

NOKIA

Nokia T20

User Guide

Table of Contents

1	About this user guide	4
2	Get started	5
	Keys and parts	5
	Insert the SIM and memory cards	6
	Charge your tablet	7
	Switch on and set up your tablet	8
	Lock or unlock your tablet	8
	Use the touch screen	8
3	Basics	12
	Control volume	12
	Automatic text correction	12
	Battery life	13
	Accessibility	13
	FM radio	14
4	Protect your tablet	15
	Protect your tablet with a screen lock	15
	Protect your tablet with your face	15
5	Camera	16
	Camera basics	16
	Videos	16
	Your photos and videos	16
6	Internet and connections	18
	Activate Wi-Fi	18
	Browse the web	18
	Bluetooth®	18
	VPN	20

7 Organize your day	21
Date and time	21
Alarm clock	21
Calendar	22
8 Maps	23
Find places and get directions	23
9 Apps, updates, and backups	24
Get apps from Google Play	24
Set up Kids Space	24
Update your tablet software	25
Back up your data	25
Restore original settings and remove private content	25
10 Product and safety information	26
For your safety	26
Network services and costs	29
Take care of your device	29
Recycle	30
Crossed-out wheellie bin symbol	30
Battery and charger information	30
Small children	32
Hearing	32
Protect your device from harmful content	32
Vehicles	32
Potentially explosive environments	33
Certification information (SAR)	33
About Digital Rights Management	34
Copyrights and other notices	34

1 About this user guide



Important: For important information on the safe use of your device and battery, read “For your safety” and “Product Safety” info in the printed user guide, or at www.nokia.com/support before you take the device into use. To find out how to get started with your new device, read the printed user guide.

2 Get started

KEYS AND PARTS

Your tablet

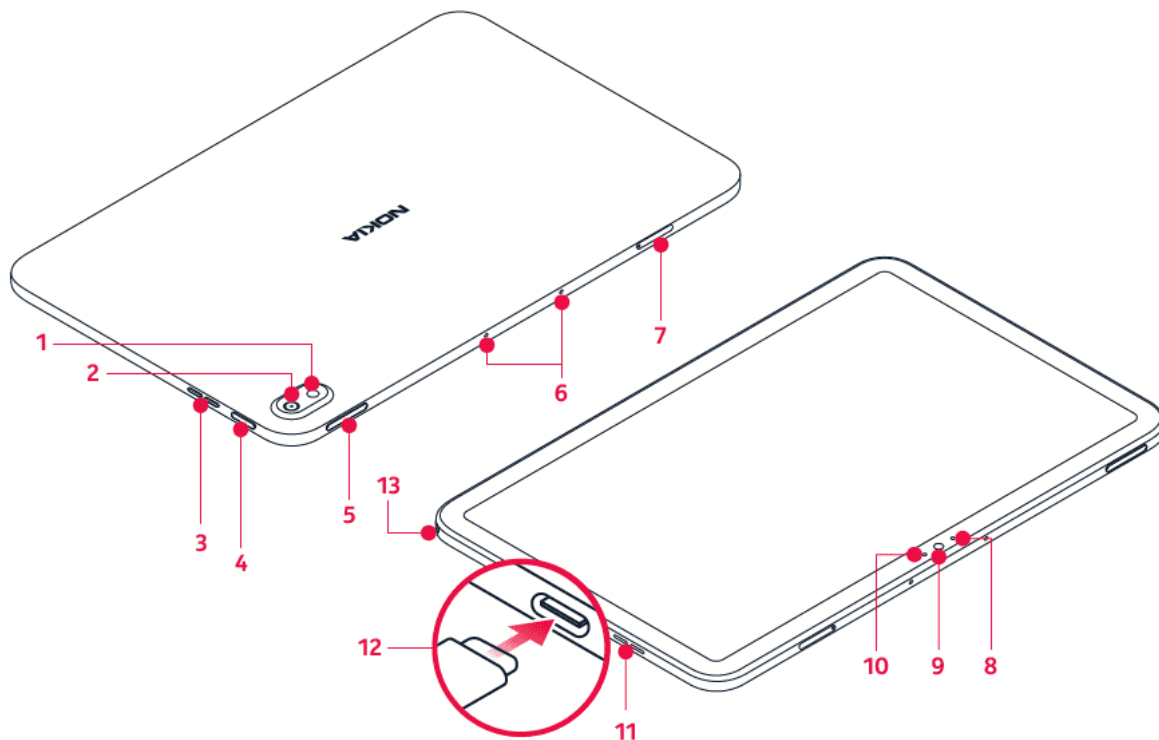

This user guide applies to the following models: TA-1394, TA-1397, TA-1392.

- | | |
|--|-----------------------|
| 1. Flash | 8. Hall sensor |
| 2. Camera | 9. Front camera |
| 3. Loudspeaker | 10. Light sensor |
| 4. Power/Lock key | 11. Loudspeaker |
| 5. Volume keys | 12. USB connector |
| 6. Microphone | 13. Headset connector |
| 7. SIM and memory card slot (TA-1394, TA-1397), memory card slot (TA-1392) | |

Some of the accessories mentioned in this user guide, such as charger, headset, or data cable, may be sold separately.

Parts and connectors, magnetism

Do not connect to products that create an output signal, as this may damage the device. Do not connect any voltage source to the audio connector. If you connect an external device or headset, other than those approved for use with this device, to the audio connector, pay special attention to volume levels.

Parts of the device are magnetic. Metallic materials may be attracted to the device. Do not place credit cards or other magnetic stripe cards near the device for extended periods of time, since the cards may be damaged.

INSERT THE SIM AND MEMORY CARDS

Insert the cards TA-1394, TA-1397

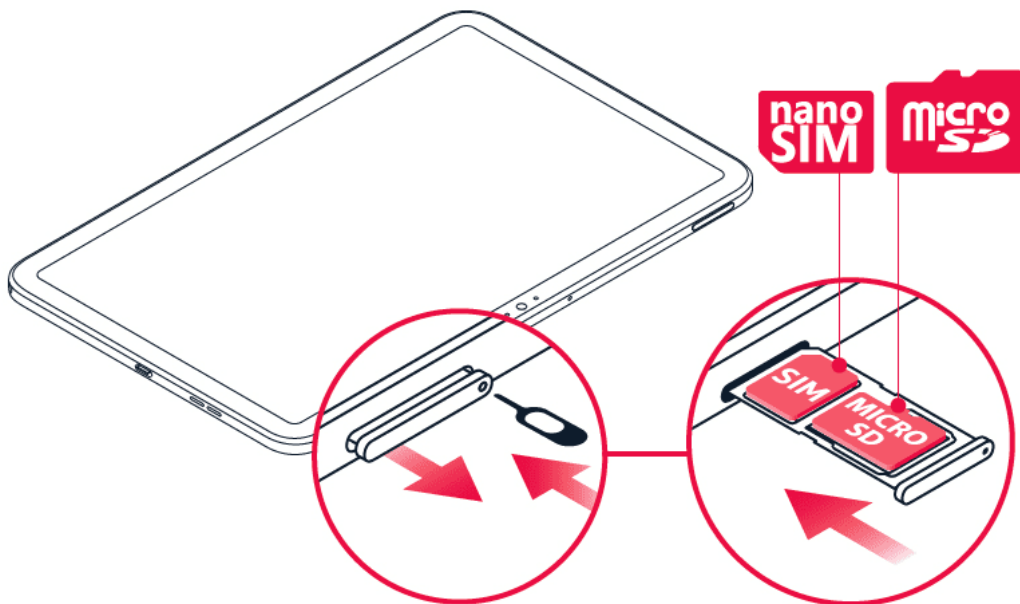

1. Open the SIM card tray: push the tray opener pin in the tray hole and slide the tray out.
2. Put the nano-SIM in the SIM slot on the tray with the contact area face down.
3. If you have a memory card, put it in the memory card slot.
4. Slide the tray back in.

Insert the memory card TA-1392

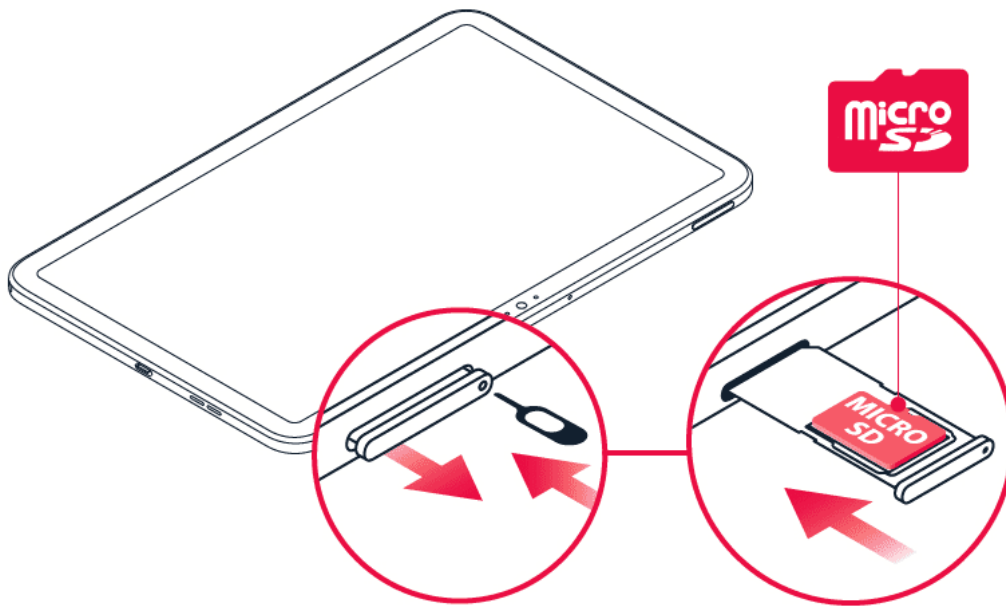

1. Open the memory card tray: push the tray opener pin in the tray hole and slide the tray out.
2. Put the memory card in the memory card slot on the tray.
3. Slide the tray back in.

 **Important:** Do not remove the memory card when an app is using it. Doing so may damage the memory card and the device and corrupt data stored on the card.

 **Tip:** Use a fast, up to 512 GB microSD memory card from a well-known manufacturer.

CHARGE YOUR TABLET

Charge the battery

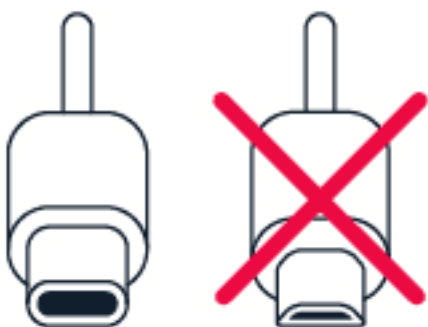

1. Plug a compatible charger into a wall outlet.

2. Connect the cable to your tablet.

Your tablet supports the USB-C cable. You can also charge your tablet from a computer with a USB cable, but it may take a longer time.

If the battery is completely discharged, it may take several minutes before the charging indicator is displayed.

SWITCH ON AND SET UP YOUR TABLET

Switch on your tablet

1. To switch on your tablet, press and hold the power key until the tablet starts up.
2. Follow the instructions shown on the screen.

LOCK OR UNLOCK YOUR TABLET

Lock your keys and screen

To lock your keys and screen, press the power key.

Unlock the keys and screen

Press the power key, and swipe up across the screen. If asked, provide additional credentials.

USE THE TOUCH SCREEN

Important: Avoid scratching the touch screen. Never use an actual pen, pencil, or other sharp object on the touch screen.

Tap and hold to drag an item

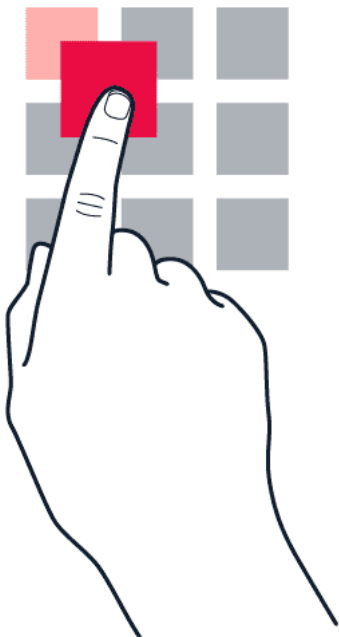

Place your finger on the item for a couple of seconds, and slide your finger across the screen.

Swipe

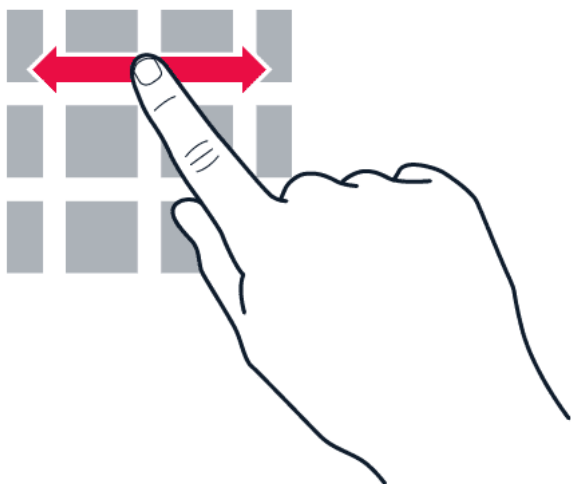

Place your finger on the screen, and slide your finger in the direction you want.

Scroll through a long list or menu



Slide your finger quickly in a flicking motion up or down the screen, and lift your finger. To stop the scrolling, tap the screen.

Zoom in or out

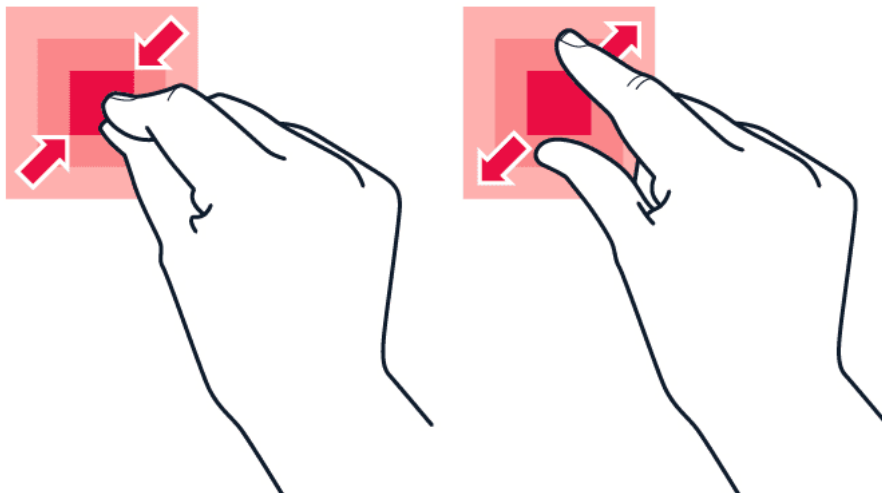

Place 2 fingers on an item, such as a map, photo, or web page, and slide your fingers apart or together.

Lock the screen orientation

The screen rotates automatically when you turn the tablet 90 degrees.

To lock the screen in portrait mode, swipe down from the top of the screen, and tap **Auto-rotate**.



Navigate with gestures

To switch on using gesture navigation, tap **Settings** > **System** > **Gestures** > **System navigation** > **Gesture navigation**.

- To see all your apps, swipe up from .
- To go to the home screen, swipe up from the bottom of the screen. The app you were in stays open in the background.
- To see which apps you have open, swipe up from the bottom of the screen without releasing your finger until you see the apps, and then release your finger.
- To switch to another open app, tap the app.
- To close all the open apps, tap **CLEAR ALL**.
- To go back to the previous screen you were in, swipe from the right or left edge of the screen. Your tablet remembers all the apps and websites you've visited since the last time your screen was locked.

Navigate with keys

To switch on the navigation keys, tap **Settings** > **System** > **Gestures** > **System navigation** > **3-button navigation**.

- To see all your apps, swipe up the home key .
- To go to the home screen, tap the home key. The app you were in stays open in the background.
- To see which apps you have open, tap .
- To switch to another open app, swipe right and tap the app.
- To close all the open apps, tap **CLEAR ALL**.
- To go back to the previous screen you were in, tap . Your tablet remembers all the apps and websites you've visited since the last time your screen was locked.

3 Basics

CONTROL VOLUME

Change the volume

To change the volume of the tablet, press the volume keys on the top left corner of your tablet.

To change the volume for media and apps, press the volume down key to see the volume status bar, tap , and drag the slider on the volume bar for media and apps left or right.

Do not connect to products that create an output signal, as this may damage the device. Do not connect any voltage source to the audio connector. If you connect an external device or headset, other than those approved for use with this device, to the audio connector, pay special attention to volume levels.

Set the tablet to silent

To set the tablet to silent, press the volume down key, and tap .

AUTOMATIC TEXT CORRECTION

Use keyboard word suggestions

Your tablet suggests words as you write, to help you write quickly and more accurately. Word suggestions may not be available in all languages.

When you start writing a word, your tablet suggests possible words. When the word you want is shown in the suggestion bar, select the word. To see more suggestions, tap and hold the suggestion.



Tip: If the suggested word is marked in bold, your tablet automatically uses it to replace the word you wrote. If the word is wrong, tap and hold it to see a few other suggestions.

If you do not want the keyboard to suggest words while typing, turn off the text corrections.

Tap **Settings** > **System** > **Languages & input** > **On-screen keyboard**. Select the keyboard you normally use. Tap **Text correction** and switch off the text correction methods you do not want to use.

Correct a word

If you notice that you have misspelled a word, tap it to see suggestions for correcting the word.

Switch spell checker off

Tap **Settings** > **System** > **Languages & input** > **Advanced** > **Spell checker**, and switch **Use spell checker** off.

BATTERY LIFE

There are steps you can take to save power on your tablet.

Extend battery life

To save power:

1. Always charge the battery fully.
2. Mute unnecessary sounds, such as touch sounds. Tap **Settings** > **Sound** > **Advanced**, and under **Other sounds**, select which sounds to keep.
3. Use wired headphones, rather than the loudspeaker.
4. Set the screen to switch off after a short time. Tap **Settings** > **Display** > **Advanced** > **Screen timeout** and select the time.
5. Tap **Settings** > **Display** > **Brightness level**. To adjust the brightness, drag the brightness level slider. Make sure that **Adaptive brightness** is disabled.
6. Stop apps from running in the background.
7. Use location services selectively: switch location services off when you don't need them. Tap **Settings** > **Location**, and disable **Use location**.
8. Use network connections selectively: Switch Bluetooth on only when needed. Use a Wi-Fi connection to connect to the internet, rather than a mobile data connection. Stop your tablet scanning for available wireless networks. Tap **Settings** > **Network & Internet** > **Wi-Fi**, and disable **Use Wi-Fi**.

ACCESSIBILITY

You can change various settings to make using your tablet easier.

Increase or decrease the font size

1. Tap **Settings** > **Accessibility**.
2. Tap **Font size**. To increase or decrease the font size, drag the font size level slider.

Increase or decrease the display size

1. Tap **Settings** > **Accessibility**.
2. Tap **Display size** and to adjust the display size, drag the display size level slider.

FM RADIO

To listen to the radio, you need to connect a compatible headset to the tablet. The headset acts as an antenna. The headset may be sold separately.

Listen to FM radio

After you have connected the headset, tap **FM Radio**.

- To switch the radio on, tap ▶. channel frequency row left or right.
- To find radio stations, tap ⋮ > **Scan**. • To save a station, tap ♥.
- To switch to another station, slide the • To switch the radio off, tap ⏻.



Troubleshooting tip: If the radio doesn't work, make sure the headset is connected properly.

4 Protect your tablet

PROTECT YOUR TABLET WITH A SCREEN LOCK

You can set your tablet to require authentication when unlocking the screen.

Set a screen lock

1. Tap **Settings** > **Security** > **Screen lock**.
2. Choose the type of lock and follow the instructions on your tablet.

PROTECT YOUR TABLET WITH YOUR FACE

Set up face authentication

1. Tap **Settings** > **Security** > **Face unlock**.
2. Select what backup unlocking method you want to use for the lock screen and follow the instructions shown on your tablet.

Keep your eyes open and make sure your face is fully visible and not covered by any object, such as a hat or sunglasses.



Note: Using your face to unlock your tablet is less secure than using a pin or a pattern. Your tablet may be unlocked by someone or something with similar appearance. Face unlock may not work properly in backlight or too dark or bright environment.

Unlock your tablet with your face

To unlock your tablet, just turn your screen on and look at the camera.

If there is a facial recognition error, and you cannot use alternative sign-in methods to recover or reset the tablet in any way, your tablet will require service. Additional charges may apply, and all the personal data on your tablet may be deleted. For more info, contact the nearest authorized service facility for your tablet, or your tablet dealer.

5 Camera



CAMERA BASICS

Take a photo



Shoot sharp and vibrant photos – capture the best moments in your photo album.

1. Tap **Camera**.
2. Take aim and focus.
3. Tap .

Take a selfie



1. Tap **Camera** >  to switch to the front camera.
2. Tap .

Take photos with a timer

1. Tap **Camera**.
2. Tap  and select the time.
3. Tap .

VIDEOS

Record a video

1. Tap **Camera**.
2. To switch to the video recording mode, slide the text **Capture** up until the text **Video** is enlarged.
3. Tap  to start recording.
4. To stop recording, tap .
5. To go back to camera mode, slide the text **Video** down until the text **Capture** is enlarged.

YOUR PHOTOS AND VIDEOS

View photos and videos on your tablet

Tap **Photos**.

Share your photos and videos

1. Tap **Photos**, tap the photo you want to share and tap .
2. Select how you want to share the photo or video.

6 Internet and connections

ACTIVATE WI-FI

Turn on Wi-Fi

1. Tap **Settings** > **Network & internet** > **Wi-Fi**.
2. Switch **Use Wi-Fi** on.
3. Select the connection you want to use.

Your Wi-Fi connection is active when  is shown on the status bar at the top of the screen.

Important: Use encryption to increase the security of your Wi-Fi connection. Using encryption reduces the risk of others accessing your data.

BROWSE THE WEB

Search the web

1. Tap **Chrome**.
2. Write a search word or a web address to the search field.
3. Tap , or select from the proposed matches.

Use your tablet to connect your computer to the web

Use your mobile data connection to access the internet with your computer or other device.

1. Tap **Settings** > **Network & internet** > **Hotspot & tethering**.
2. Switch on **Wi-Fi hotspot** to share your mobile data connection over Wi-Fi, **USB tethering** to use a USB connection, **Bluetooth tethering** to use Bluetooth, or **Ethernet tethering** to use a USB Ethernet cable connection.

The other device uses data from your data plan, which may result in data traffic costs. For info on availability and costs, contact your network service provider.

BLUETOOTH®

Connect to a Bluetooth device

1. Tap **Settings** > **Connected devices** > **Connection preferences** > **Bluetooth**.
2. Switch **Bluetooth** to **On**.
3. Make sure the other device is switched on. You may need to start the pairing process from the other device. For details, see the user guide for the other device.
4. Tap **Pair new device** and tap the device you want to pair with from the list of discovered Bluetooth devices.
5. You may need to type in a passcode. For details, see the user guide for the other device.

Since devices with Bluetooth wireless technology communicate using radio waves, they do not need to be in direct line-of-sight. Bluetooth devices must, however, be within 10 meters (33 feet) of each other, although the connection may be subject to interference from obstructions such as walls or from other electronic devices.

Paired devices can connect to your tablet when Bluetooth is switched on. Other devices can detect your tablet only if the Bluetooth settings view is open.

Do not pair with or accept connection requests from an unknown device. This helps to protect your tablet from harmful content.

Share your content using Bluetooth

If you want to share your photos or other content with a friend, send them to your friend's device using Bluetooth.

You can use more than one Bluetooth connection at a time. For example, while using a Bluetooth headset, you can still send things to another device.

1. Tap **Settings** > **Connected devices** > **Connection preferences** > **Bluetooth**.
2. Make sure Bluetooth is switched on in both devices and the devices are visible to each other.
3. Go to the content you want to send, and tap  > **Bluetooth**.
4. On the list of found Bluetooth devices, tap your friend's device.
5. If the other device needs a passcode, type in or accept the passcode, and tap **Pair**.

The passcode is only used when you connect to something for the first time.

Remove a pairing

If you no longer have the device with which you paired your tablet, you can remove the pairing.

1. Tap **Settings** > **Connected devices** > **PREVIOUSLY CONNECTED DEVICES**.
2. Tap  next to a device name.
3. Tap **FORGET**.

VPN

You may need a virtual private network (VPN) connection to access your company resources, such as intranet or corporate mail, or you may use a VPN service for personal purposes.

Contact your company IT administrator for details of your VPN configuration, or check your VPN service's website for additional info.

Use a secure VPN connection

1. Tap **Settings** > **Network & Internet** > **Advanced** > **VPN**.
2. To add a VPN profile, tap **+**.
3. Type in the profile info as instructed by your company IT administrator or VPN service.

Edit a VPN profile

1. Tap  next to a profile name.
2. Change the info as required.

Delete a VPN profile

1. Tap  next to a profile name.
2. Tap **FORGET**.

7 Organize your day

DATE AND TIME

Set date and time

Tap **Settings** > **System** > **Date & time** .

Update the time and date automatically

You can set your tablet to update the time, date, and time zone automatically. Automatic update is a network service and may not be available depending on your region or network service provider.

1. Tap **Settings** > **System** > **Date & time** .
2. Switch **Use network-provided time** on.
3. Switch **Use network-provided time zone** on.

Change the clock to the 24-hour format

Tap **Settings** > **System** > **Date & time** , and switch **Use 24-hour format** on.

ALARM CLOCK

Set an alarm

1. Tap **Clock** > **Alarm** .
2. To add an alarm, tap **+** .
3. To modify an alarm, tap it. To set the alarm to repeat on specific dates, check **Repeat** and highlight the days of the week.

Switch an alarm off

When the alarm sounds, swipe the alarm right.

CALENDAR

Manage calendars

Tap **Calendar** > ≡, and select what type of calendar you want to see.

Calendars are added automatically when you add an account to your tablet. To add a new account with a calendar, go to the apps menu and tap **Settings** > **Accounts** > **Add account**.

Add an event

1. In **Calendar**, tap **+**.
2. Type in the details you want, and set the time.
3. To make an event repeat on certain days, tap **Does not repeat**, and select how often the event should repeat.
4. To set a reminder, tap **Add notification**, set the time and tap **Done**.
5. Tap **Save**.



Tip: To edit an event, tap the event and , and edit the details.

Delete an appointment

1. Tap the event.
2. Tap **:** > **Delete**.

8 Maps

FIND PLACES AND GET DIRECTIONS

Find a spot

Google Maps helps you find specific locations and businesses.

1. Tap **Maps**.
2. Write search words, such as a street address or place name, in the search bar.
3. Select an item from the list of proposed matches as you write, or tap  to search.

The location is shown on the map. If no search results are found, make sure the spelling of your search words is correct.

See your current location

Tap **Maps** > .

Get directions to a place

1. Tap **Maps** and enter your destination in the search bar.
2. Tap **Directions**. The highlighted icon shows the mode of transportation, for example . To change the mode, select the new mode under the search bar.
3. If you don't want the starting point to be your current location, tap **Your location**, and search for a new starting point.
4. Tap **Start** to start the navigation.

9 Apps, updates, and backups

GET APPS FROM GOOGLE PLAY

You need to have a Google account added to your tablet to use Google Play services. Charges may apply to some of the content available in Google Play. To add a payment method, tap **Play Store**, tap your Google logo next to the search field, and then tap **Payment methods**. Always be sure to have a permission from the payment method owner when buying content from Google Play.

Add a Google account to your tablet

1. Tap **Settings** > **Accounts** > **Add account** > **Google**. If asked, confirm your device lock method.
2. Type in your Google account credentials and tap **Next**, or, to create a new account, tap **Create account**.
3. Follow the instructions on your tablet.

Download apps

1. Tap **Play Store**.
2. Tap the search bar to look for apps, or select apps from your recommendations.
3. In the app description, tap **Install** to download and install the app.

To see your apps, go to the home screen and swipe up from the bottom of the screen.

SET UP KIDS SPACE

Fun for kids

Kids Space offers pre-loaded apps, books, and videos for children. To use Kids Space, your child needs a supervised Google account.

Tap **Kids Space** > **Get started** > **Create an account**, and follow the instructions on your tablet's screen.

UPDATE YOUR TABLET SOFTWARE

Install available updates

Tap **Settings** > **System** > **Advanced** > **System update** > **Check for update** to check if updates are available.

When your tablet notifies you that an update is available, just follow the instructions shown on your tablet. If your tablet is low on memory, you may need to move your photos and other stuff to the memory card.

Warning: If you install a software update, you cannot use the device until the installation is completed and the device is restarted.

Before starting the update, connect a charger or make sure the device battery has enough power, and connect to Wi-Fi, as the update packages may use up a lot of mobile data.

BACK UP YOUR DATA

To ensure your data is safe, use the backup feature in your tablet. Your device data (such as Wi-Fi passwords and call history) and app data (such as settings and files stored by apps) will be backed up remotely.

Switch on automatic backup

Tap **Settings** > **System** > **Backup**, and switch back up on.

RESTORE ORIGINAL SETTINGS AND REMOVE PRIVATE CONTENT

Reset your tablet

1. Tap **Settings** > **System** > **Advanced** > **Reset options** > **Erase all data (factory reset)**.
2. Follow the instructions shown on your tablet.

10 Product and safety information

FOR YOUR SAFETY

Read these simple guidelines. Not following them may be dangerous or against local laws and regulations. For further info, read the complete user guide.

SWITCH OFF IN RESTRICTED AREAS



Switch the device off when mobile device use is not allowed or when it may cause interference or danger, for example, in aircraft, in hospitals or near medical equipment, fuel, chemicals, or blasting areas. Obey all instructions in restricted areas.

ROAD SAFETY COMES FIRST



Obey all local laws. Always keep your hands free to operate the vehicle while driving. Your first consideration while driving should be road safety.

INTERFERENCE



All wireless devices may be susceptible to interference, which could affect performance.

AUTHORIZED SERVICE



Only authorized personnel may install or repair this product.

BATTERIES, CHARGERS, AND OTHER ACCESSORIES



Use only batteries, chargers, and other accessories approved by HMD Global Oy for use with this device. Do not connect incompatible products.

KEEP YOUR DEVICE DRY



If your device is water-resistant, see its IP rating in the device's technical specifications for more detailed guidance.

GLASS PARTS



The device and/or its screen is made of glass. This glass can break if the device is dropped on a hard surface or receives a substantial impact. If the glass breaks, do not touch the glass parts of the device or attempt to remove the broken glass from the device. Stop using the device until the glass is replaced by authorized service personnel.

PROTECT YOUR HEARING



To prevent possible hearing damage, do not listen at high volume levels for long periods. Exercise caution when holding your device near your ear while the loudspeaker is in use.

SAR



This device meets RF exposure guidelines when used either in the normal use position against the ear or when positioned at least 1.5 centimetres (5/8 inch) away from the body. The specific maximum SAR values can be found in the Certification Information (SAR) section of this user guide. For more information, see the Certification Information (SAR) section of this user guide or go to www.sar-tick.com.

NETWORK SERVICES AND COSTS

Using some features and services, or downloading content, including free items, require a network connection. This may cause the transfer of large amounts of data, which may result in data costs. You may also need to subscribe to some features.



Important: 4G/LTE might not be supported by your network service provider or by the service provider you are using when traveling. In these cases, you may not be able to make or receive calls, send or receive messages or use mobile data connections. To make sure your device works seamlessly when full 4G/LTE service is not available, it is recommended that you change the highest connection speed from 4G to 3G. To do this, on the home screen, tap **Settings** > **Network & Internet** > **Mobile network**, and switch **Preferred network type** to **3G**.



Note: Using Wi-Fi may be restricted in some countries. For example, in the EU, you are only allowed to use 5150–5350 MHz Wi-Fi indoors, and in the USA and Canada, you are only allowed to use 5.15–5.25 GHz Wi-Fi indoors. For more info, contact your local authorities. For more info, contact your network service provider.

TAKE CARE OF YOUR DEVICE

Handle your device, battery, charger and accessories with care. The following suggestions help you keep your device operational.

- Keep the device dry. Precipitation, humidity, and all types of liquids or moisture can contain minerals that corrode electronic circuits.
- Do not use or store the device in dusty or dirty areas.
- Do not store the device in high temperatures. High temperatures may damage the device or battery.
- Do not store the device in cold temperatures. When the device warms to its normal temperature, moisture can form inside the device and damage it.
- Do not open the device other than as instructed in the user guide.
- Unauthorized modifications may damage the device and violate regulations governing radio devices.
- Do not drop, knock, or shake the device or the battery. Rough handling can break it.
- Only use a soft, clean, dry cloth to clean the surface of the device.
- Do not paint the device. Paint can prevent proper operation.
- Keep the device away from magnets or magnetic fields.
- To keep your important data safe, store it in at least two separate places, such as your device, memory card, or computer, or write down important info.

During extended operation, the device may feel warm. In most cases, this is normal. To avoid getting too warm, the device may automatically slow down, dim display during a video call, close apps, switch off charging, and if necessary, switch itself off. If the device is not working properly, take it to the nearest authorized service facility.

RECYCLE



Always return your used electronic products, batteries, and packaging materials to dedicated collection points. This way you help prevent uncontrolled waste disposal and promote the recycling of materials. Electrical and electronic products contain a lot of valuable materials, including metals (such as copper, aluminum, steel, and magnesium) and precious metals (such as gold, silver, and palladium). All materials of the device can be recovered as materials and energy.

CROSSED-OUT WHEELIE BIN SYMBOL

Crossed-out wheelie bin symbol



The crossed-out wheelie bin symbol on your product, battery, literature, or packaging reminds you that all electrical and electronic products and batteries must be taken to separate collection at the end of their working life. Do not dispose of these products as unsorted municipal waste: take them for recycling. For info on your nearest recycling point, check with your local waste authority.

BATTERY AND CHARGER INFORMATION

Battery and charger info

To check if your tablet has a removable or non-removable battery, see the Get started guide.

Devices with a removable battery Use your device only with an original rechargeable battery. The battery can be charged and discharged hundreds of times, but it will eventually wear out. When the standby time is noticeably shorter than normal, replace the battery.

Devices with a non-removable battery Do not attempt to remove the battery, as you may damage the device. The battery can be charged and discharged hundreds of times, but it will eventually wear out. When the standby time is noticeably shorter than normal, to replace the battery, take the device to the nearest authorized service facility.

Charge your device with a compatible charger. Charger plug type may vary. Charging time can vary depending on device capability.

Battery and charger safety info

Once charging of your device is complete, unplug the charger from the device and electrical outlet. Please note that continuous charging should not exceed 12 hours. If left unused, a fully charged battery will lose its charge over time.

Extreme temperatures reduce the capacity and lifetime of the battery. Always keep the battery between 15°C and 25°C (59°F and 77°F) for optimal performance. A device with a hot or cold battery may not work temporarily. Note that the battery may drain quickly in cold temperatures and lose enough power to switch off the device within minutes. When you are outdoors in cold temperatures, keep your device warm.

Obey local regulations. Recycle when possible. Do not dispose as household waste.

Do not expose the battery to extremely low air pressure or leave it to extremely high temperature, for example dispose it in a fire, as that may cause the battery to explode or leak flammable liquid or gas.

Do not dismantle, cut, crush, bend, puncture, or otherwise damage the battery in any way. If a battery leaks, do not let liquid touch skin or eyes. If this happens, immediately flush the affected areas with water, or seek medical help. Do not modify, attempt to insert foreign objects into the battery, or immerse or expose it to water or other liquids. Batteries may explode if damaged.

Use the battery and charger for their intended purposes only. Improper use, or use of unapproved or incompatible batteries or chargers may present a risk of fire, explosion, or other hazard, and may invalidate any approval or warranty. If you believe the battery or charger is damaged, take it to a service centre or your device dealer before continuing to use it. Never use a damaged battery or charger. Only use the charger indoors. Do not charge your device during a lightning storm. When charger is not included in the sales pack, charge your device using the data cable (included) and a USB power adaptor (may be sold separately). You can charge your device with third-party cables and power adaptors that are compliant with USB 2.0 or later and with applicable country regulations and international and regional safety standards. Other adaptors may not meet applicable safety standards, and charging with such adaptors could pose a risk of property loss or personal injury.

To unplug a charger or an accessory, hold and pull the plug, not the cord.

Additionally, the following applies if your device has a removable battery:

- Always switch the device off and unplug the charger before removing the battery.
- Accidental short-circuiting can happen when a metallic object touches the metal strips on the battery. This may damage the battery or the other object.

SMALL CHILDREN

Your device and its accessories are not toys. They may contain small parts. Keep them out of the reach of small children.

HEARING



Warning: When you use the headset, your ability to hear outside sounds may be affected. Do not use the headset where it can endanger your safety.

Some wireless devices may interfere with some hearing aids.

PROTECT YOUR DEVICE FROM HARMFUL CONTENT

Your device may be exposed to viruses and other harmful content. Take the following precautions:

- Be cautious when opening messages. They may contain malicious software or otherwise be harmful to your device or computer.
- Be cautious when accepting connectivity requests, browsing the internet, or downloading content. Do not accept Bluetooth connections from sources you do not trust.
- Only install and use services and software from sources that you trust and that offer adequate security and protection.
- Install antivirus and other security software on your device and any connected computer. Only use one antivirus app at a time. Using more may affect performance and operation of the device and/or computer.
- If you access preinstalled bookmarks and links to third party internet sites, take the appropriate precautions. HMD Global does not endorse or assume liability for such sites.

VEHICLES

Radio signals may affect improperly installed or inadequately shielded electronic systems in vehicles. For more info, check with the manufacturer of your vehicle or its equipment. Only authorized personnel should install the device in a vehicle. Faulty installation may be dangerous and invalidate your warranty. Check regularly that all wireless device equipment in your vehicle is mounted and operating properly. Do not store or carry flammable or explosive materials in the same compartment as the device, its parts, or accessories. Do not place your device or accessories in the air bag deployment area.

POTENTIALLY EXPLOSIVE ENVIRONMENTS

Switch your device off in potentially explosive environments, such as near gasoline pumps. Sparks may cause an explosion or fire resulting in injury or death. Note restrictions in areas with fuel; chemical plants; or where blasting operations are in progress. Areas with a potentially explosive environment may not be clearly marked. These usually are areas where you are advised to switch your engine off, below deck on boats, chemical transfer or storage facilities, and where the air contains chemicals or particles. Check with the manufacturers of vehicles using liquefied petroleum gas (such as propane or butane) if this device can be safely used in their vicinity.

CERTIFICATION INFORMATION (SAR)

This mobile device meets guidelines for exposure to radio waves.

Your mobile device is a radio transmitter and receiver. It is designed not to exceed the limits for exposure to radio waves (radio frequency electromagnetic fields), recommended by international guidelines from the independent scientific organization ICNIRP. These guidelines incorporate substantial safety margins that are intended to assure the protection of all persons regardless of age and health. The exposure guidelines are based on the Specific Absorption Rate (SAR), which is an expression of the amount of radio frequency (RF) power deposited in the head or body when the device is transmitting. The ICNIRP SAR limit for mobile devices is 2.0 W/kg averaged over 10 grams of tissue.

SAR tests are carried out with the device in standard operating positions, transmitting at its highest certified power level, in all its frequency bands.

Please refer to www.nokia.com/phones/sar for the maximum SAR value of the device.

This device meets RF exposure guidelines when used against the head or when positioned at least 5/8 inch (1.5 centimetres) away from the body. When a carry case, belt clip or other form of device holder is used for body-worn operation, it should not contain metal and should provide at least the above stated separation distance from the body.

To send data or messages, a good connection to the network is needed. Sending may be delayed until such a connection is available. Follow the separation distance instructions until the sending is finished.

During general use, the SAR values are usually well below the values stated above. This is because, for purposes of system efficiency and to minimize interference on the network, the operating power of your mobile is automatically decreased when full power is not needed for the call. The lower the power output, the lower the SAR value.

Device models may have different versions and more than one value. Component and design changes may occur over time and some changes could affect SAR values.

For more info, go to www.sar-tick.com. Note that mobile devices may be transmitting even if you are not making a voice call.

The World Health Organization (WHO) has stated that current scientific information does not indicate the need for any special precautions when using mobile devices. If you are interested

in reducing your exposure, they recommend you limit your usage or use a hands-free kit to keep the device away from your head and body. For more information and explanations and discussions on RF exposure, go to the WHO website at www.who.int/peh-emf/en.

ABOUT DIGITAL RIGHTS MANAGEMENT

When using this device, obey all laws and respect local customs, privacy and legitimate rights of others, including copyrights. Copyright protection may prevent you from copying, modifying, or transferring photos, music, and other content.

COPYRIGHTS AND OTHER NOTICES

Copyrights and other notices

The availability of some products, features, applications and services described in this guide may vary by region and require activation, sign up, network and/or internet connectivity and an appropriate service plan. For more info, contact your dealer or your service provider. This device may contain commodities, technology or software subject to export laws and regulations from the US and other countries. Diversion contrary to law is prohibited.

The contents of this document are provided "as is". Except as required by applicable law, no warranties of any kind, either express or implied, including, but not limited to, the implied warranties of merchantability and fitness for a particular purpose, are made in relation to the accuracy, reliability or contents of this document. HMD Global reserves the right to revise this document or withdraw it at any time without prior notice.

To the maximum extent permitted by applicable law, under no circumstances shall HMD Global or any of its licensors be responsible for any loss of data or income or any special, incidental, consequential or indirect damages howsoever caused.

Reproduction, transfer or distribution of part or all of the contents in this document in any form without the prior written permission of HMD Global is prohibited. HMD Global operates a policy of continuous development. HMD Global reserves the right to make changes and improvements to any of the products described in this document without prior notice.

HMD Global does not make any representations, provide a warranty, or take any responsibility for the functionality, content, or end-user support of third-party apps provided with your device. By using an app, you acknowledge that the app is provided as is.

Downloading of maps, games, music and videos and uploading of images and videos may involve transferring large amounts of data. Your service provider may charge for the data transmission. The availability of particular products, services and features may vary by region. Please check with your local dealer for further details and availability of language options.

Certain features, functionality and product specifications may be network dependent and subject to additional terms, conditions, and charges.

All specifications, features and other product information provided are subject to change without notice.

HMD Global Privacy Policy, available at <http://www.nokia.com/phones/privacy>, applies to your use of the device.

HMD Global Oy is the exclusive licensee of the Nokia brand for phones & tablets. Nokia is a registered trademark of Nokia Corporation.

Android, Google and other related marks and logos are trademarks of Google LLC.

The Bluetooth word mark and logos are owned by the Bluetooth SIG, Inc. and any use of such marks by HMD Global is under license.

Use the Low blue light mode



Blue light is a color in the visible light spectrum that can be seen by the human eye. Of all the colors that the human eye perceives (violet, indigo, blue, green, yellow, orange, red), blue has the shortest wavelength and thus produces a higher amount of energy. Since blue light passes through your eye's cornea and lens before reaching the retina, it may cause itchy and red eyes, headaches, blurred vision, and poor sleep, for example. To limit and reduce blue light, the display industry has developed solutions such as the Low blue light mode. To switch on the Low blue light mode on your tablet, tap **Settings** > **Display** > **Night Light** > **Turn on**. If you need to look at your tablet's screen for a long time, take frequent breaks and relax your eyes by looking at distant objects.

OZO



OZO is a trademark of Nokia Technologies Oy.